

1/14

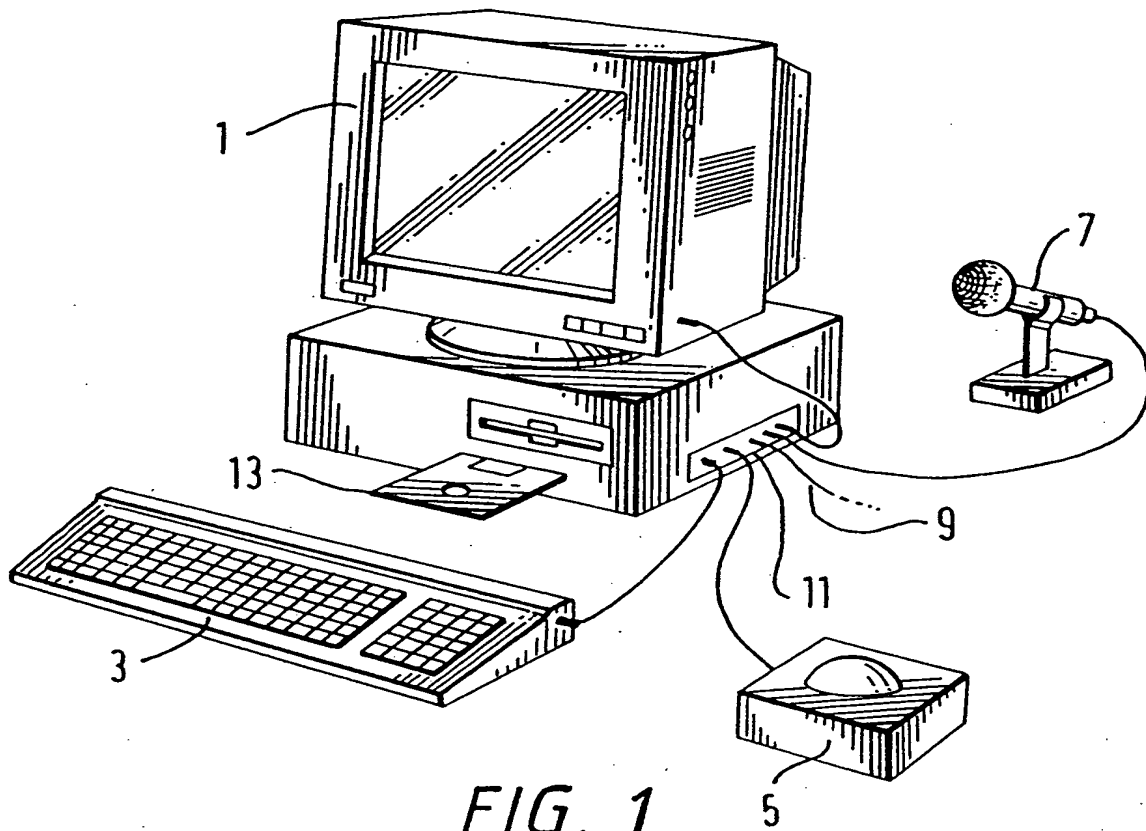

FIG. 1

FIG. 2

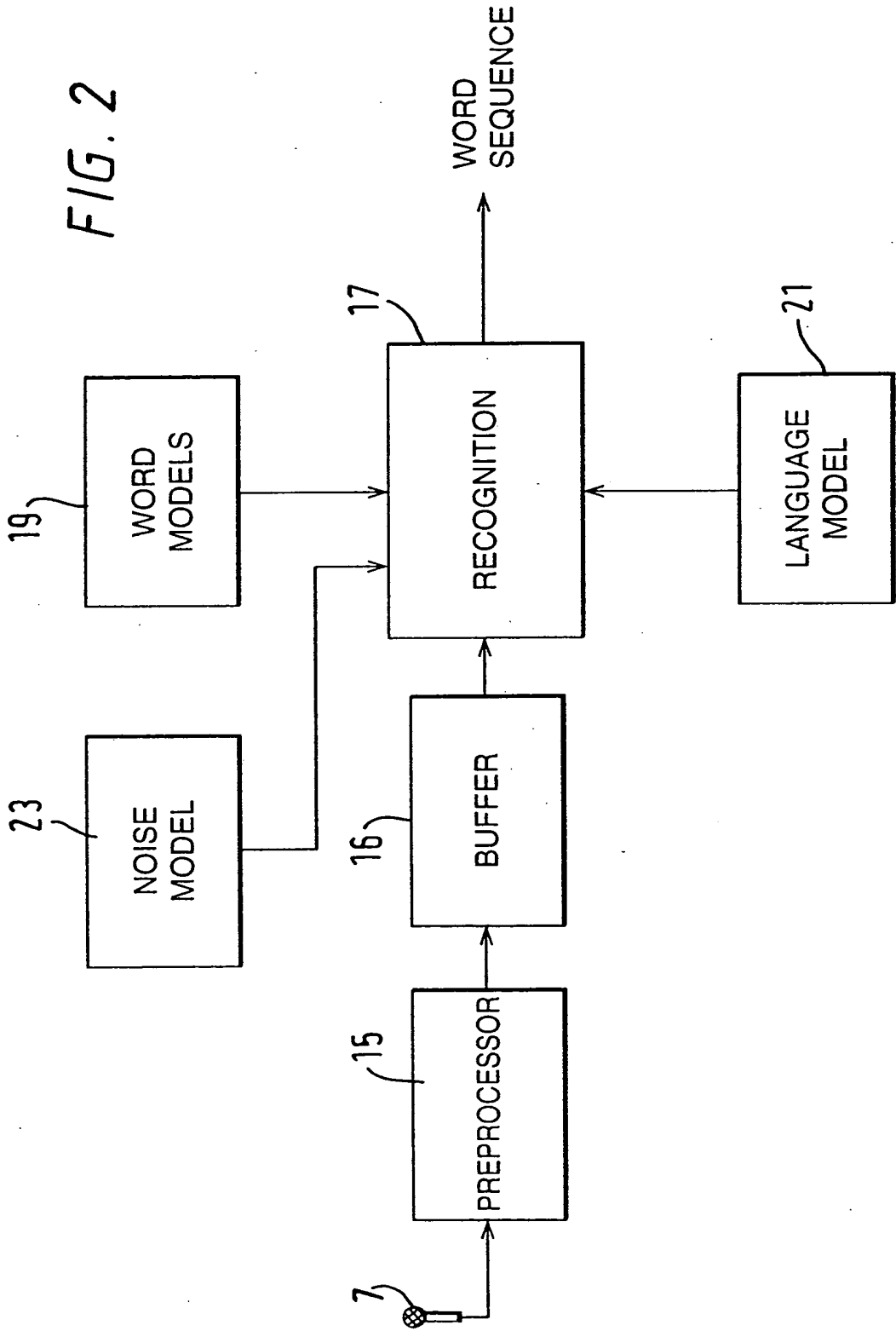
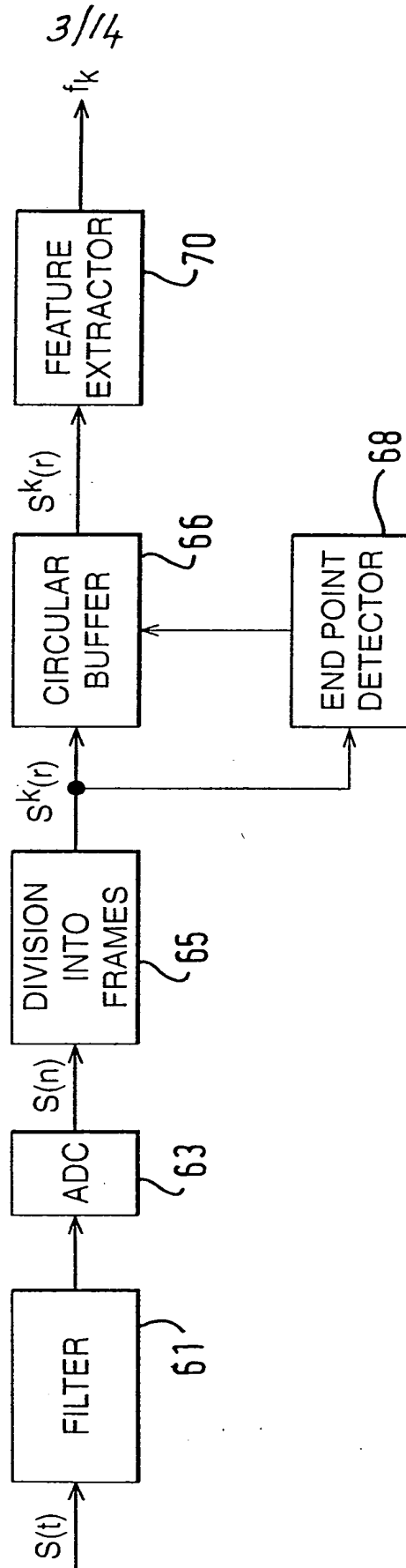

FIG. 3



4/14

FIG. 4

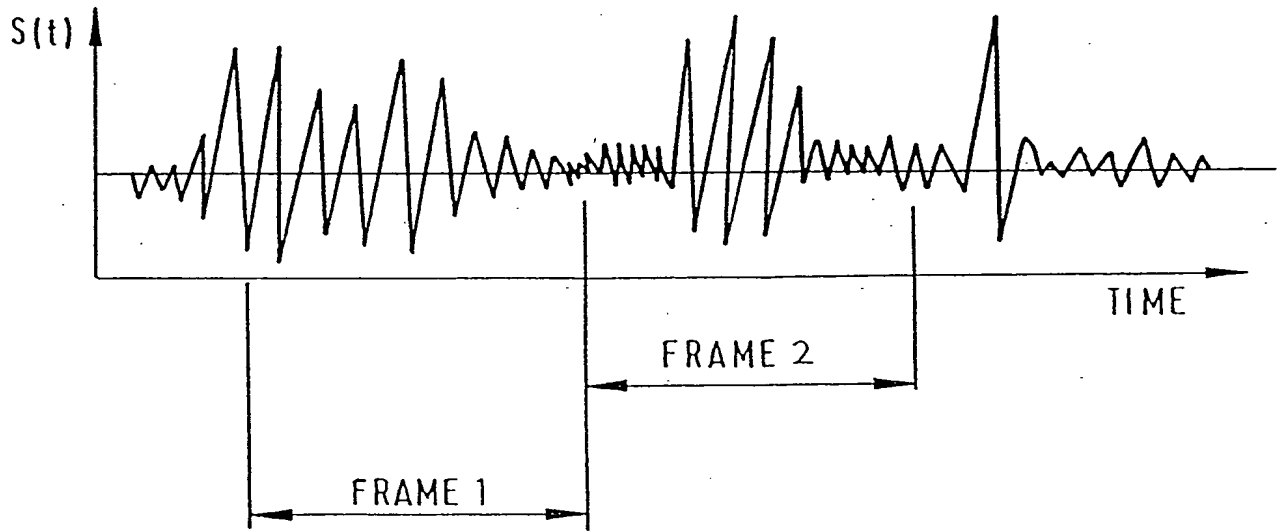
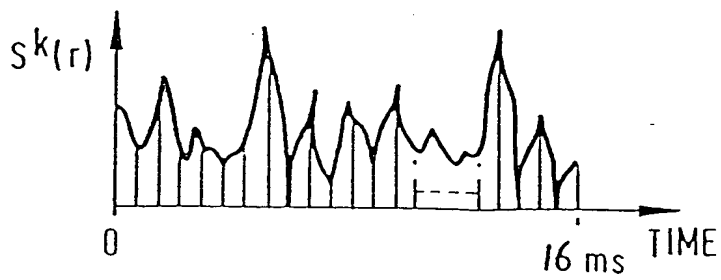

FIG. 5



5/14

FIG. 6a

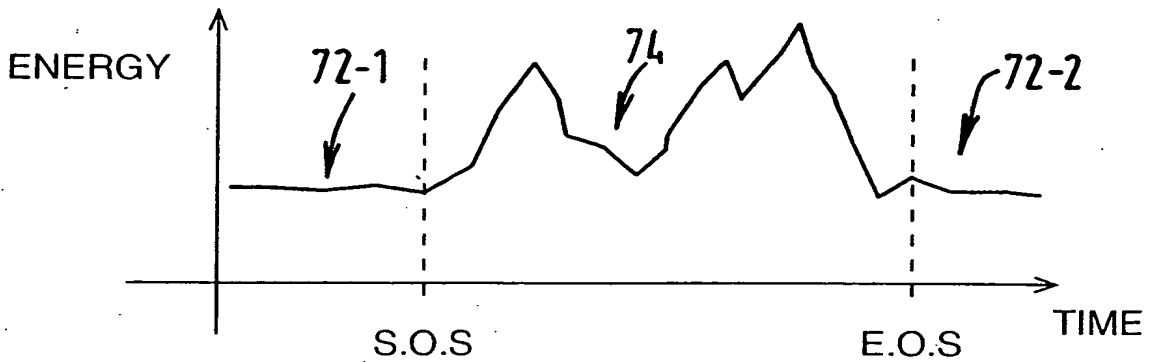

FIG. 6b

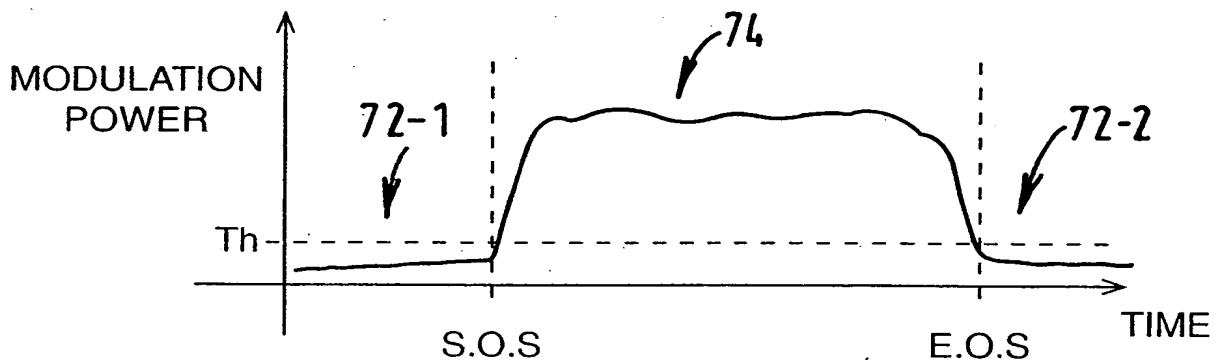
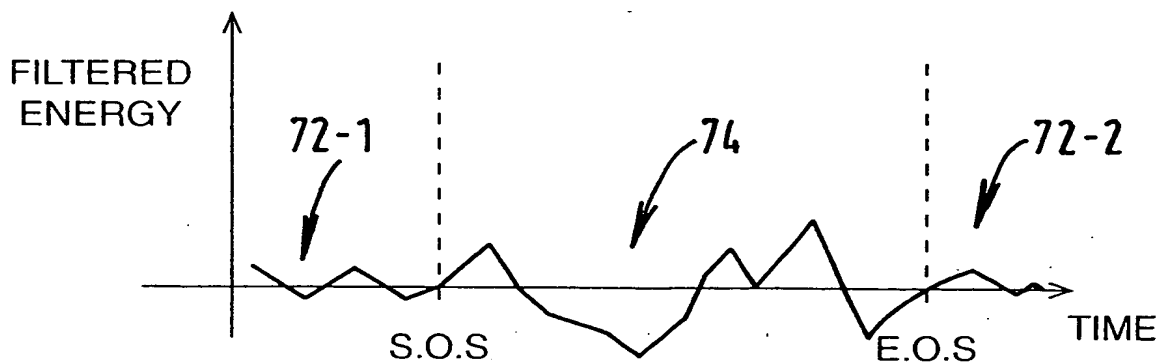

FIG. 9



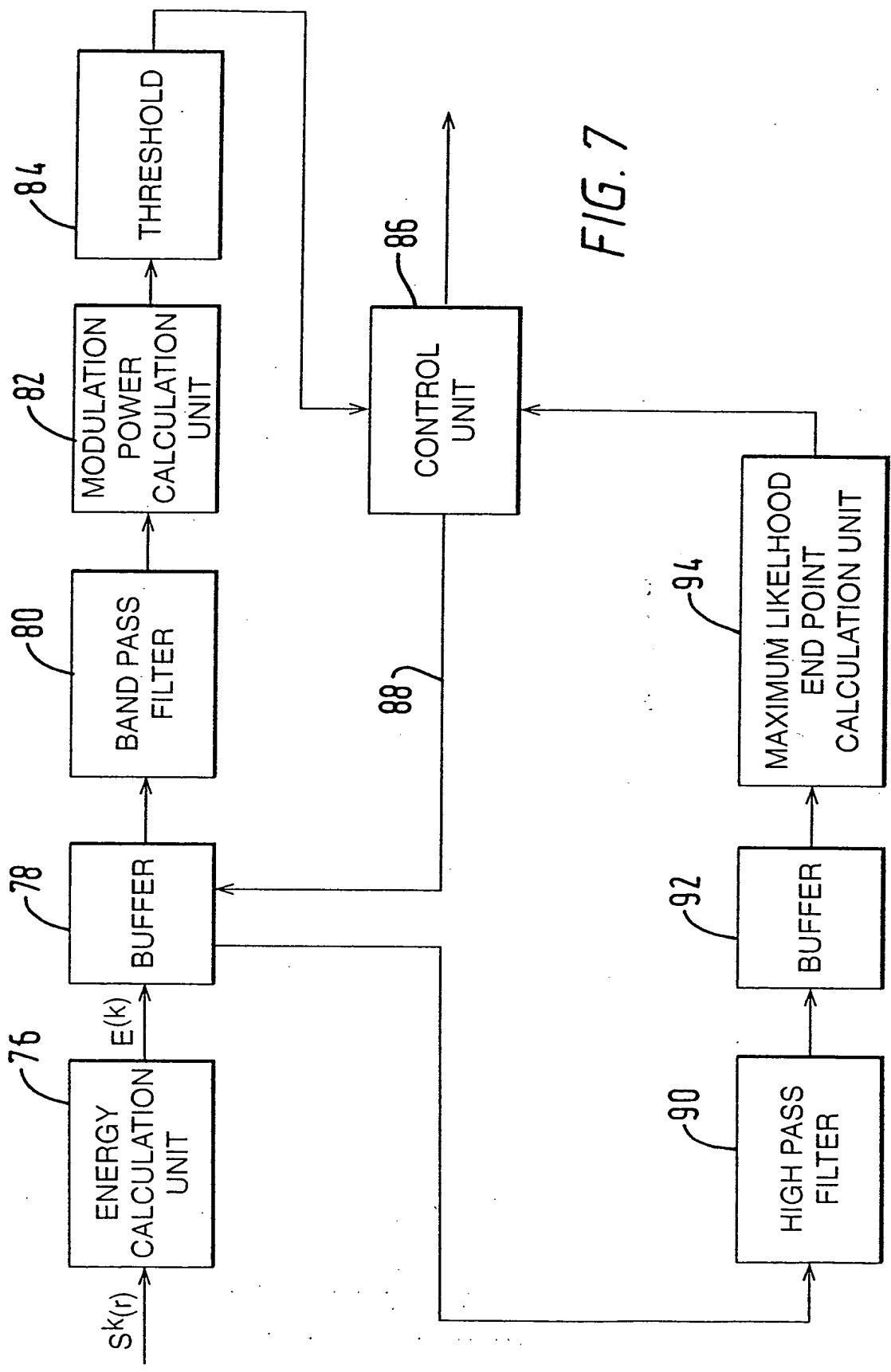

FIG. 7

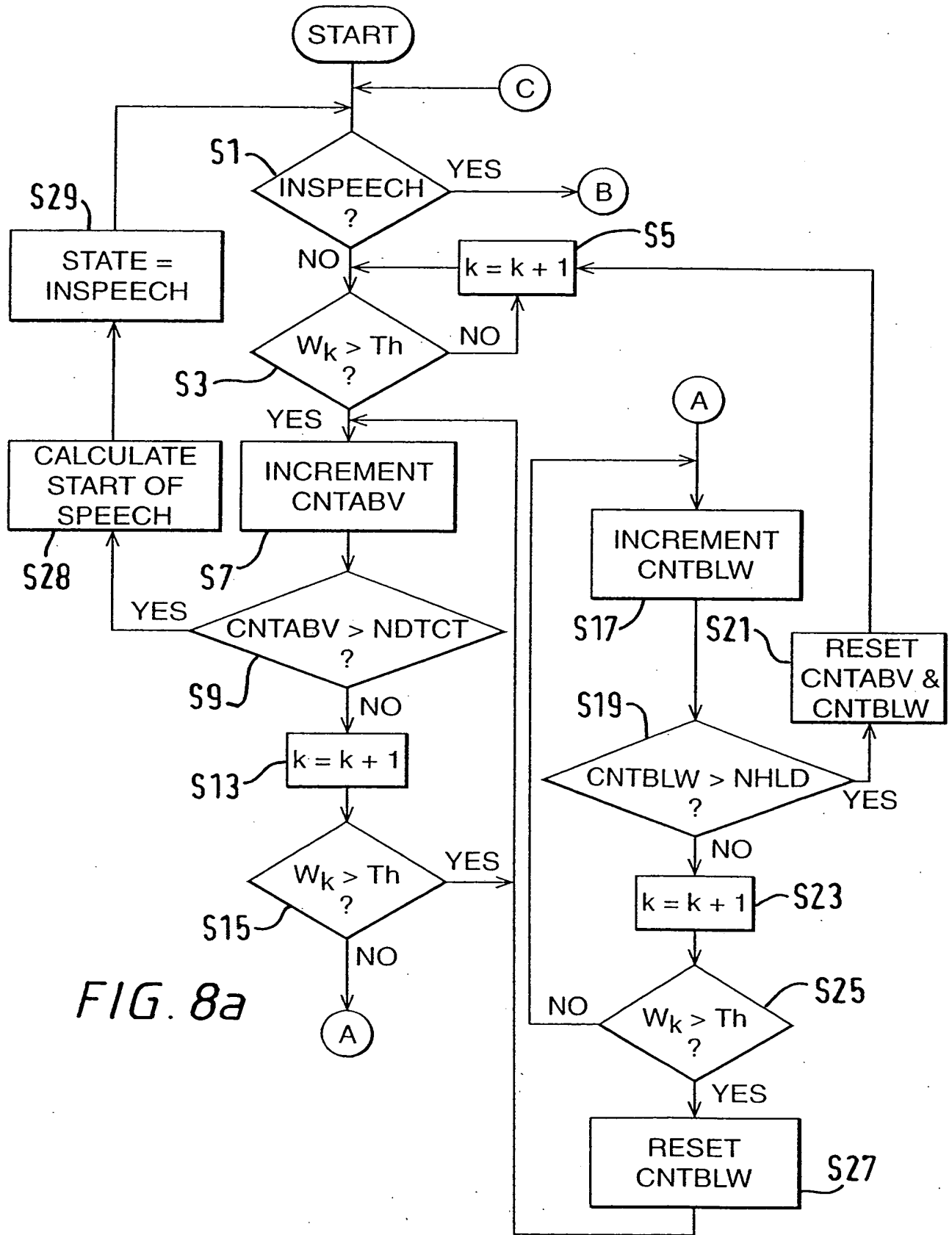

FIG. 8a

8/14
FIG. 8b

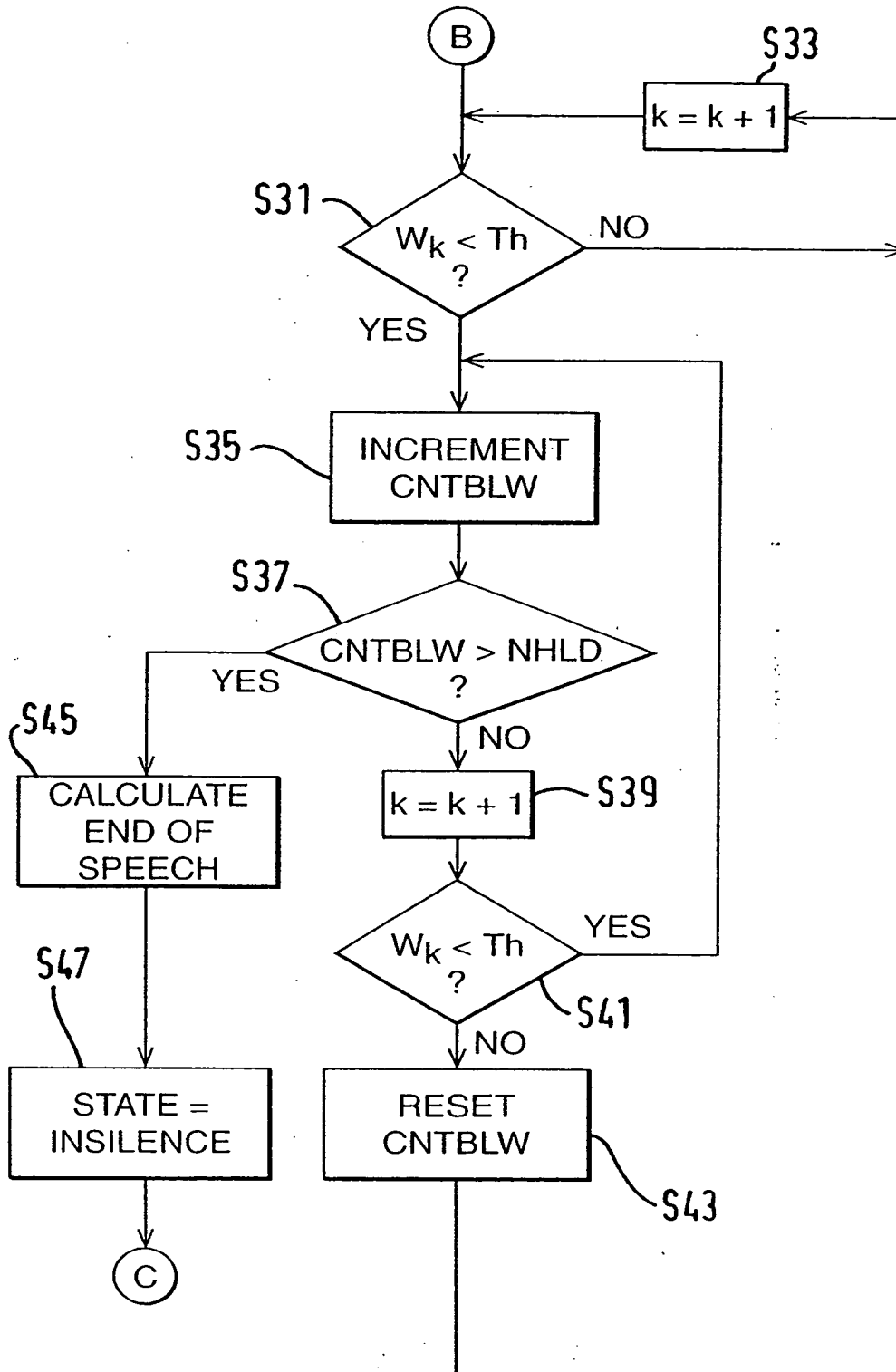
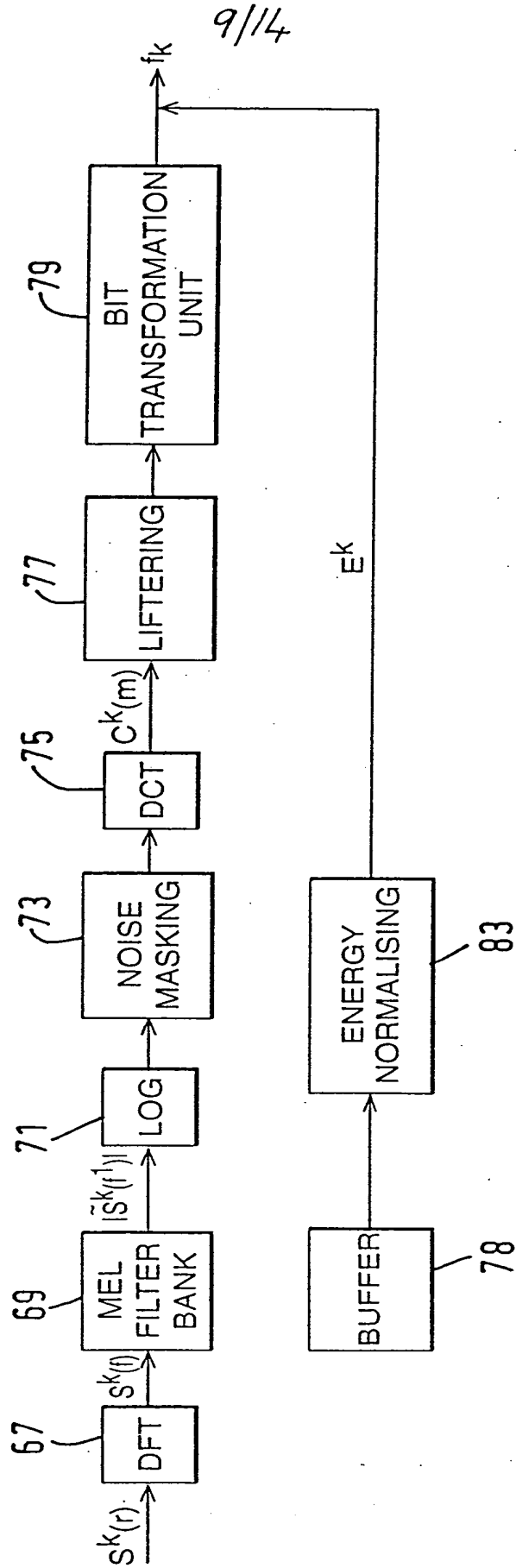

FIG. 10



10/14

FIG. 11

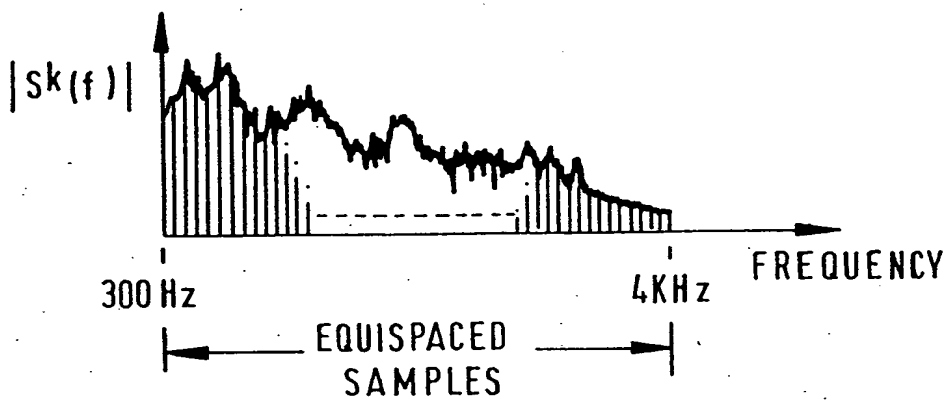

FIG. 12

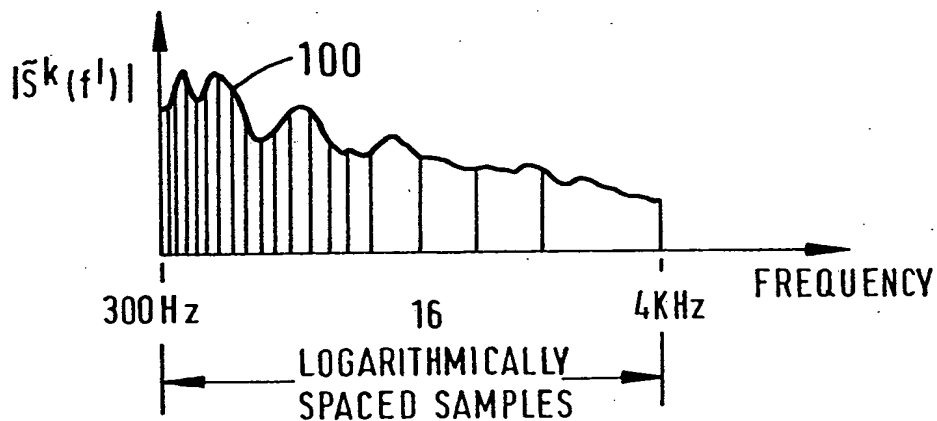
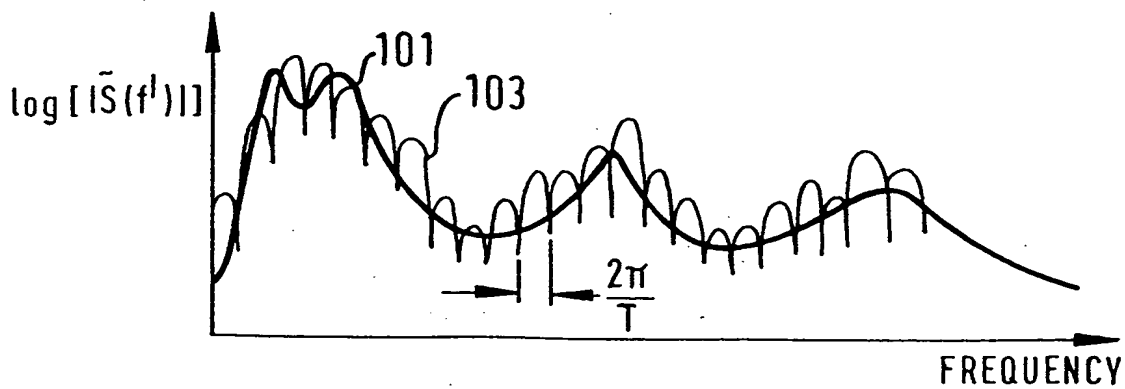
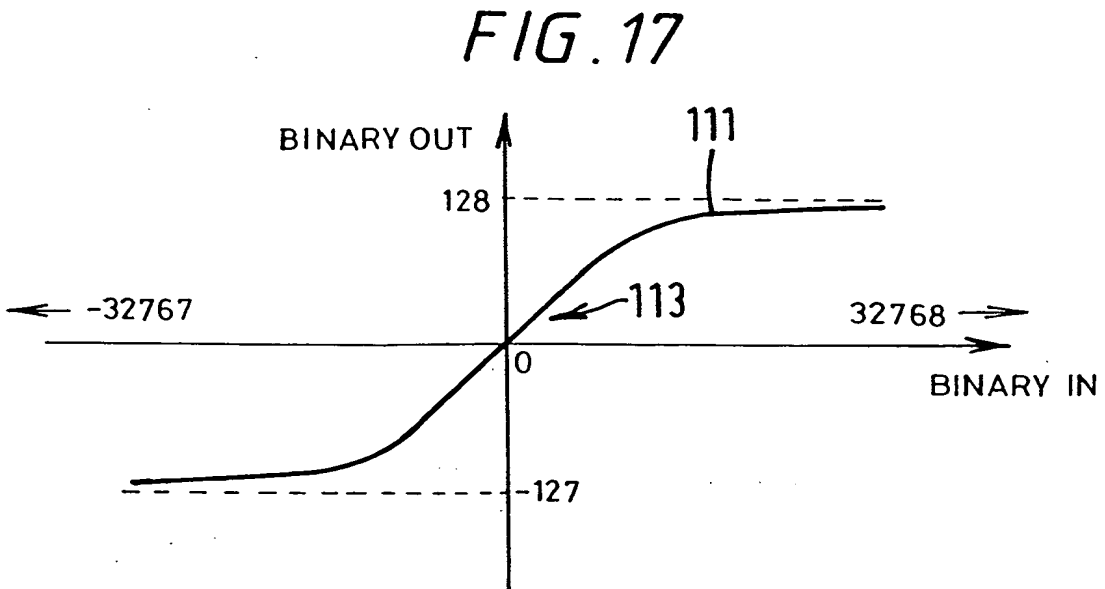
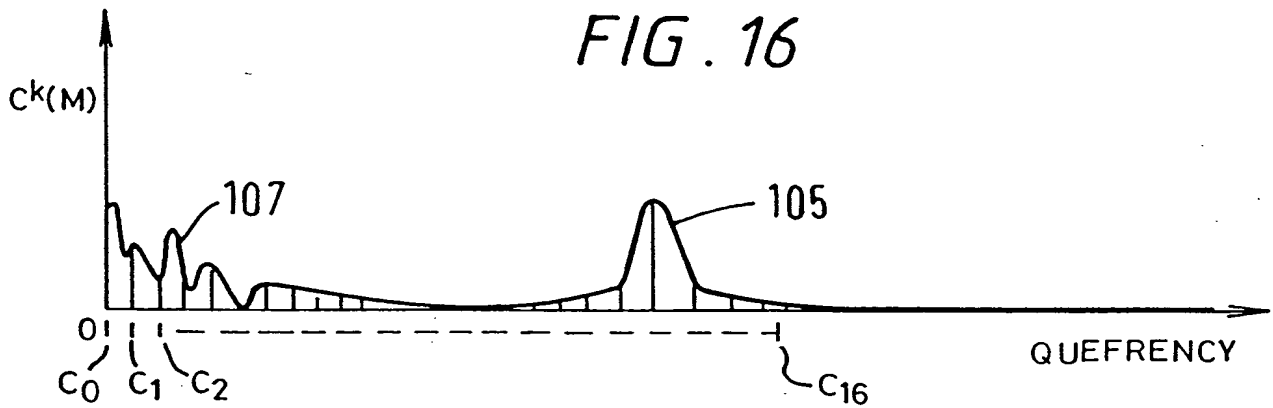
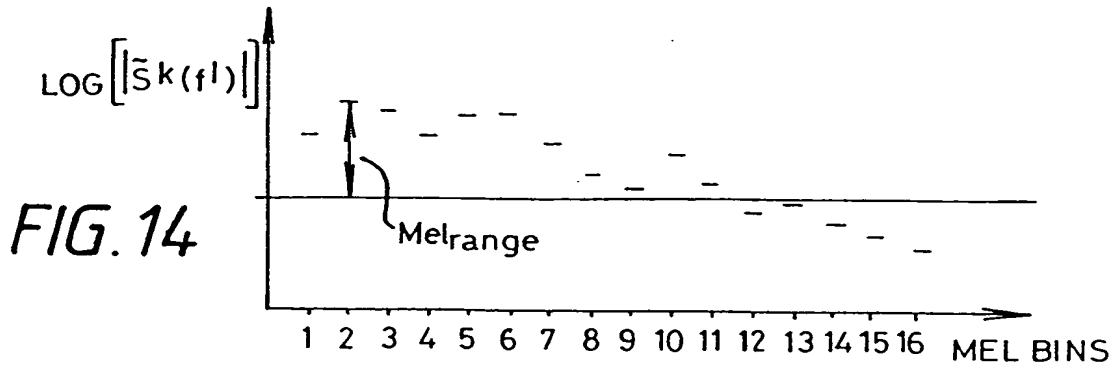
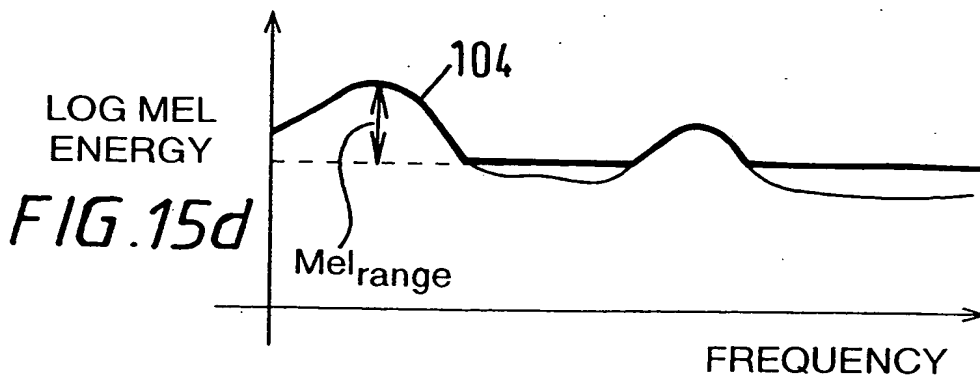
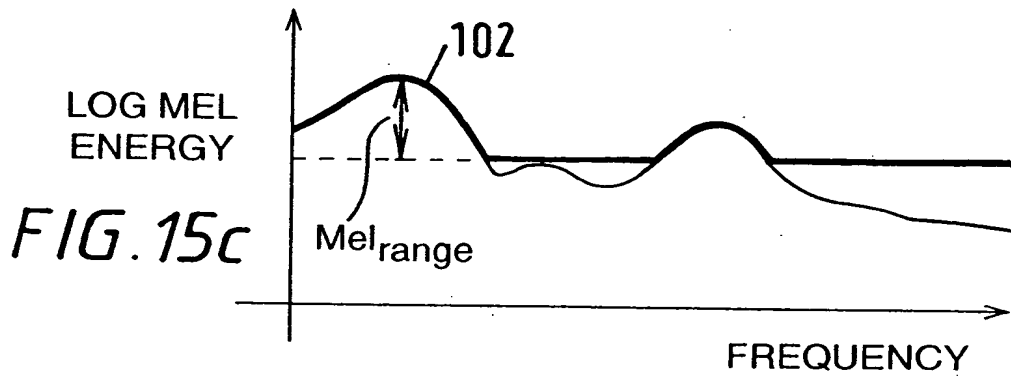
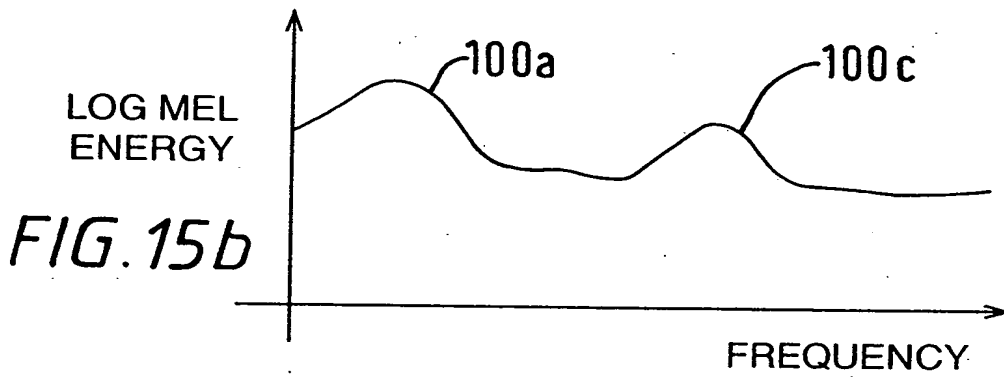
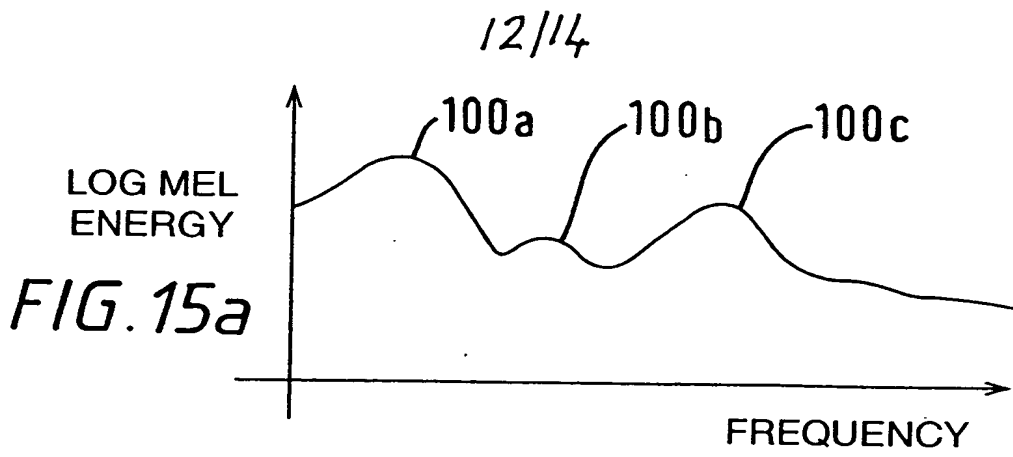

FIG. 13







13/14

FIG. 18a

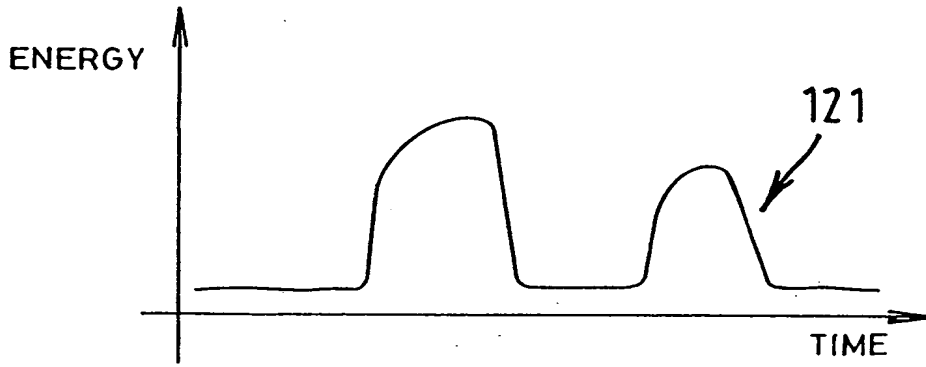

FIG. 18b

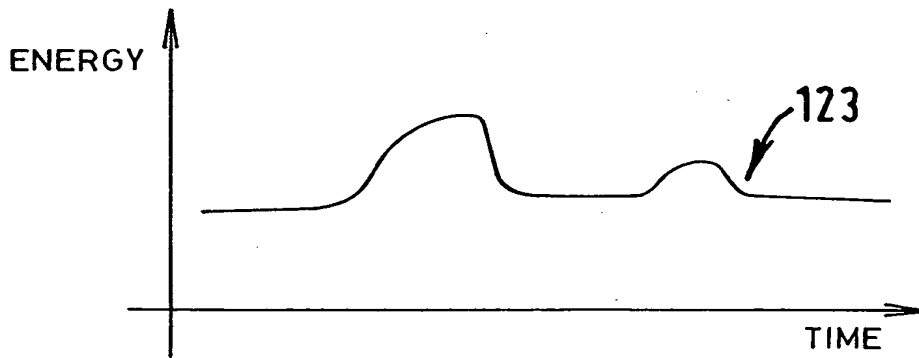

FIG. 18c

